

XXX

X: 0mm

Y: 0mm

Z: 0mm

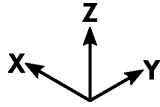

X 400 mm

Y 500 mm

Z 318 mm

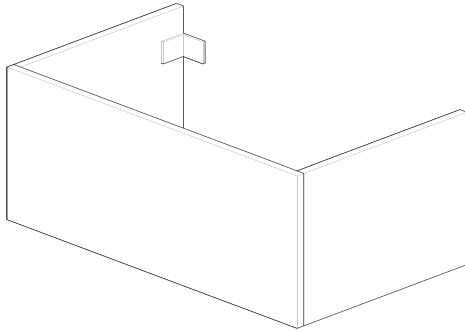

A



A mm

B mm

C mm

D mm

E mm

F mm

G mm

H mm

I mm

J mm

M 51 mm

N mm

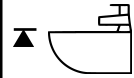
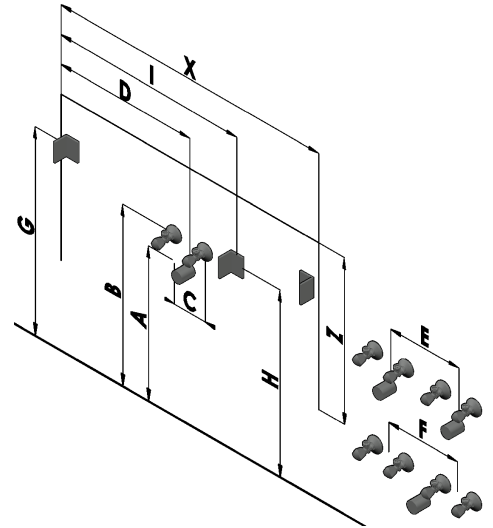

J

Art.No



max. 50 Kg

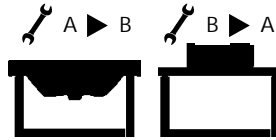
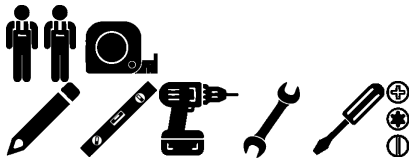
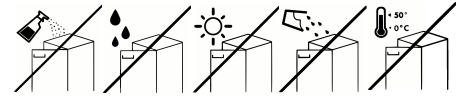

A



~~SILICONE~~

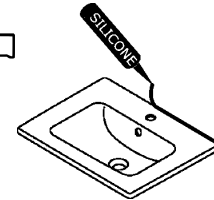

B

